

**FAMOUS
TOLEDO**

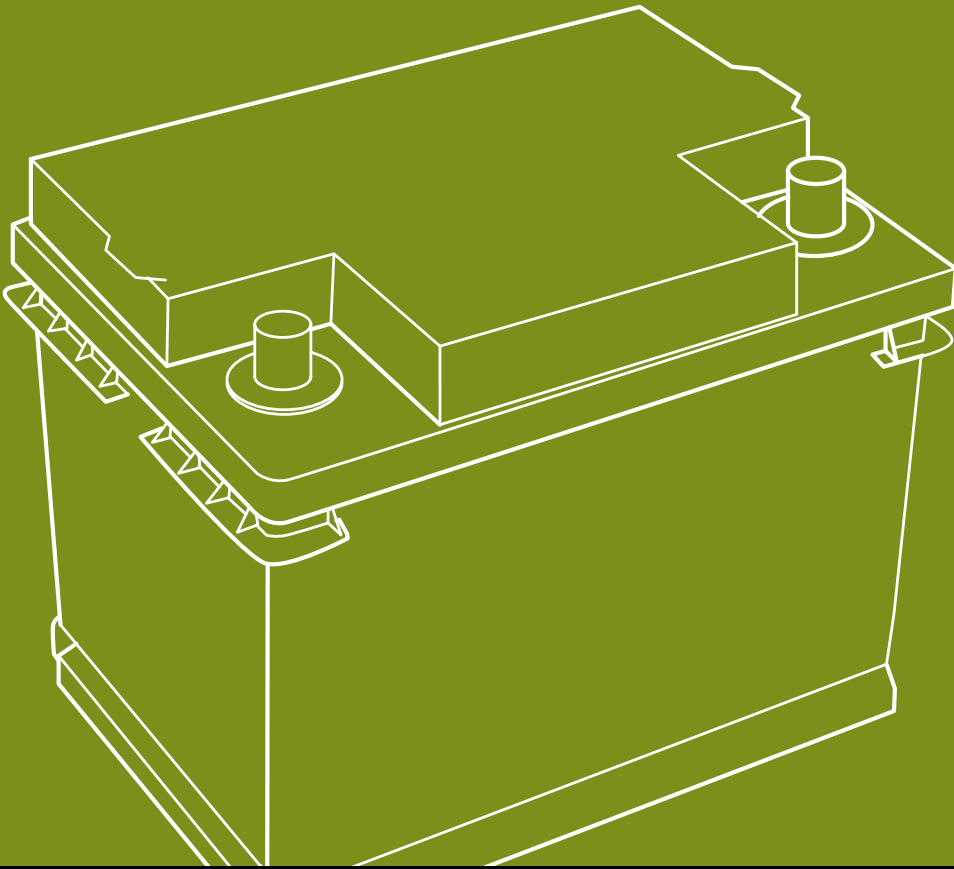

ELECTRICAL SERVICE

Wire Piercing Guide

302003

- Quickly and easily guides tester probe into the centre of vehicle electrical wires
- Eliminates stabbing of fingers when piercing wires
- Holds the circuit tester in position enabling both hands to be free to work on the electrical system
- Resistant to oil, fuel and thinners



Heavy Duty Circuit Tester 6, 12, 24 Volt

302144

- Tests a multitude of electrical circuits 6-24 Volt, AC or DC
- Durable 100mm cellulose acetate handles
- 121mm stainless steel probe with point cover
- 1500mm of tough flexible wire
- Heavy duty crocodile ground clip



Professional Circuit Tester 6, 12 Volt

302145

- Versatile performer required by anyone working on 6 and 12 volt circuitry HD
- Probe and crocodile ground clip
- Lights up when the circuit is active
- Long retractable cable extends up to 3600mm



Circuit Tester Extra Long 6, 12 Volt

302001

- Suitable for 6, 12 volt electrical systems
- Extra long insulated probe 165mm
- Long retractable cable extends up to 3600mm



Polarity Circuit Tester 6-28 Volt

302146

- No earth wire or clip required
- Detects from 6-28 Volts
- Liquid crystal display shows polarity
- Rugged carbon fibre reinforced plastic construction
- Uses no batteries
- Cap with pocket clip makes carrying and storing safe and convenient
- Safe with ECM's, sensors, airbags and transducers etc

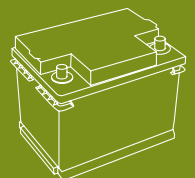

Electrical
Service

Battery & Alternator Tester

302147

- LED display indicates battery condition with the engine off
- Displays alternator output with the engine running
- Indicator shows poor, fair or good condition
- Inbuilt magnetic backboard enables hands free operation for easier testing



Car Light Tester (Brass Body) 6-24 Volt

302148

- Sharp circuit connection tip with brass cap
- Brass casing body
- Checks function of car lights fast and easily



Car Lead Tester

302149

- Checks high or low tension leads
- Tests battery charge condition with three light emitting diodes
- Checks current draw

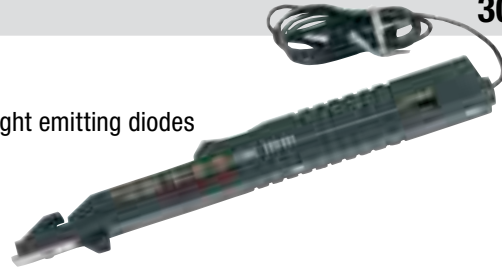

Battery Voltage Tester 0-16 Volt

302150

- A must for starting, charging or battery tests as well as many other electrical checks
- Single function meter with large face for simplicity and easy reading 0-16 Volt DC scale, suitable for all automotive electrical systems
- Convenient probe and alligator ground clip



Relay & Fuse Plier

302151

- Removes and installs most types of relays and fuses
- Eliminates awkward hand relay removal
- Coated tips ensure firm grip of relay or fuse

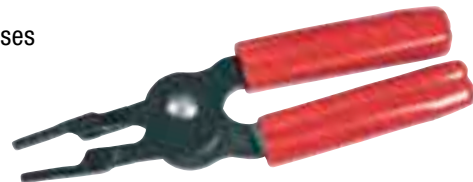

Relay Plier Angle Tip

302152

- Removes and installs most relays
- Eliminates awkward hand relay removal
- Angle tip for easy access
- Coated tip ensures firm grip

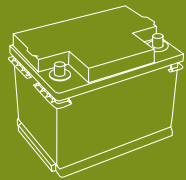

High Tension Lead & Fuse Plier

302162

- High insulation properties are resistant to oil, water and heat to 150°C
- Nylon tongs allow the high-tension leads to be removed whilst the engine is still running
- Removes 25mm cartridge fuses



Spark Plug Boot Plier

302160

- Prevents high voltage shocks when removing plug boots
- Insulated jaws and handles
- Also suitable for light bulb removal
- 200mm overall length

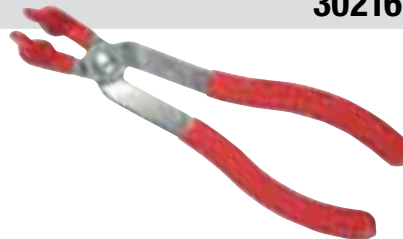

Bulb Plier

302022

- Enables easy removal and replacement of wedge style bulbs

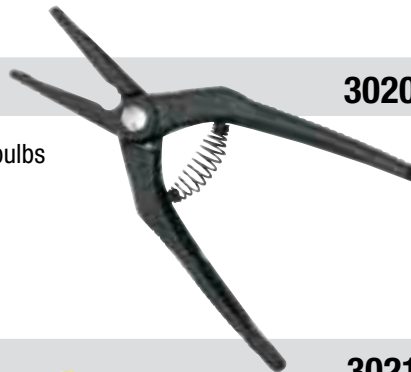

Spark Plug Lead Puller

302161

- Prevents high voltage shocks when removing plug boots
- Nylon tool, lightweight
- Eliminates shocks and insulates from heat
- Removes leads quickly
- Also suitable for light bulb removal



Wire and Coax Strippers

WS210

- Automatic wire stripper
- Wire cutter
- Crimps insulated, non insulated and auto ignition terminals



WS210

WS665

- Heavy Duty
- Cuts soft copper/aluminium cable. Crimps insulated, non-insulated and auto ignition terminals



WS665

Part No.	Wire Size	Description
WS210	0.13-6.0mm ²	Wire & Coax Stripper
WS665	0.20-6.0mm ²	Wire & Coax Stripper

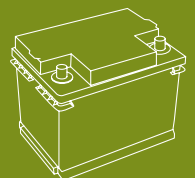

Electrical
Service

Ratchet Crimping Tool

302021

- Crimps insulated terminals - red, blue, yellow
- Heavy duty steel construction, PVC coated handles
- Ratchet release handles



Cable Lug Crimping Pliers Ratchet

302023

- Ratchet action crimping pliers suits lug cable sizes:
10mm² (8 B & S), 16mm² (6 B & S),
25mm² (3 B & S), 35mm² (2 B & S)

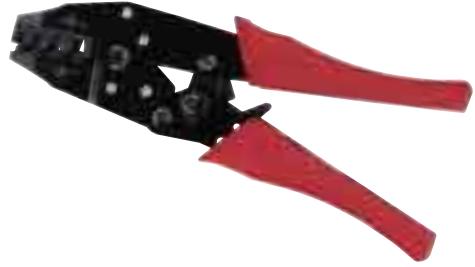

Cable Lug Crimping Tool

302025

- Hand crimps cable lugs with ease
- Suits cable sizes 10mm² to 120mm² (8 B & S to 000 BS)
- Professional quality
- Single crimp
- Overall length 560mm



Cable Lug Crimping Tool Heavy Duty

302024

- Hand crimping tool
- Suits cable sizes 10 to 120mm² (8 B & S to 000 B & S)
- Six sided hexagonal crimp
- Overall length 630mm

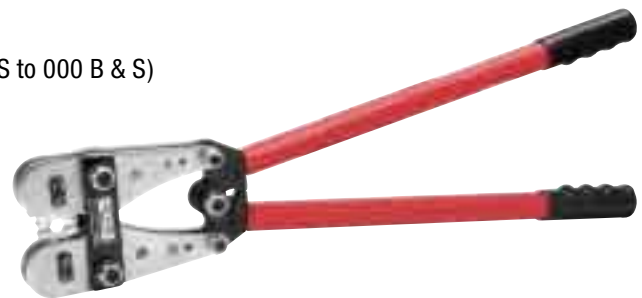

7 in 1 Wire Stripper & Crimper

302155

- Multi function tool features:
 - Plier nose
 - Wire stripper / Wire cutter
 - Screw cutter
 - Crimps insulated and non-insulated terminals
 - 7-8mm auto crimp

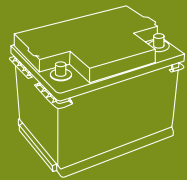
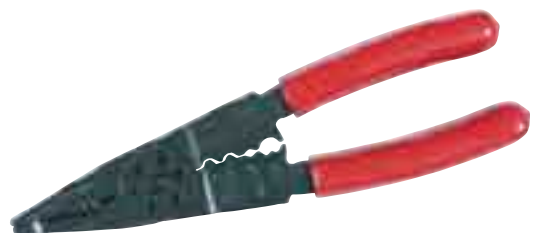

Electrical
Service

Wire Stripper, Crimper, Cutter

CT2010

- Suitable for wire up to 6mm²

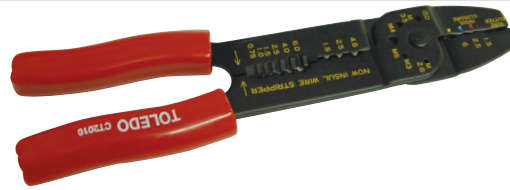

Heavy Duty Ratchet Crimper

CT16

- Suitable for wire up to 16mm²
- 1-2mm, 6mm, 10mm, 16mm



Memory Retainer Power Supply

302154

- Maintains memory functions of vehicle radios, clocks and computers when the battery is disconnected
- Simply attach a 9 volt battery then plug the tool into the cigarette lighter
- Retains settings for up to 4 hours



Remote Control Starter Switch

302004

- Starter switch used to bypass ignition switch by connecting starter to solenoid
- Heavy duty rubber insulated copper wire complete with insulated clips
- Ideal for generator, starter, electrical tests, fuel pump tests, setting points, adjusting tappets and compression checks



Alternator Bit Set

302005

- Comprehensive set designed for alternator service work
- Spline and Torx Socket Bits for the removal of Bosch type alternator free-wheel drive pulleys

Part No.	Description
302006	T50 x 113mm socket bit
302007	M10 x 113mm socket bit
302008	Replacement bit set – 6 pce (M8, M10, T50, T40, H10, H8)
302009	Spline H15 x 33mm
302010	Spline H22 x 33mm
302011	H22 nut
302012	4pt H17 x 33mm adaptor
302013	Bit Socket Holder

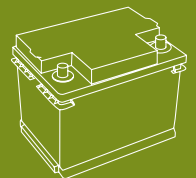

Electrical
Service

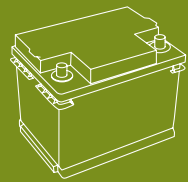

Electrical Service

Dashboard Service Tool Kit

302153

- 8 piece kit specially designed for the servicing or removal of meters, gauges, radios, accessories and locks
- All the tools you require for dashboard and auxiliary service work



Radio Removal Tool Ford

302156

- Makes radio removal fast, easy and damage free on Philips & Eurovox
- Suits Ford, GM and imported vehicles

Directions for use:

- Insert radio removal tools into holes on radio face-plate
- Insert into radio about 25mm to release retaining clips
- Remove from instrument panel using the tools as handles



Radio Removal Set European Vehicles

302178

- Compact set of pocket size tools designed for the safe and speedy radio removal from a range of quality European vehicles
- Suits Audi, BMW, Mercedes Benz and VW

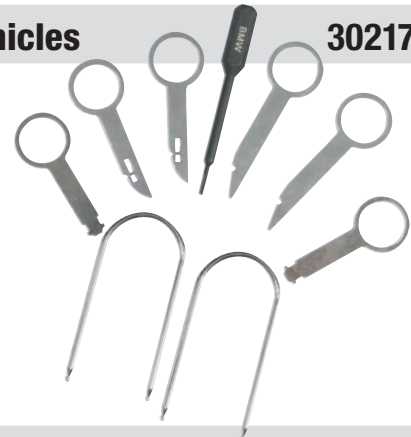

Antenna Removal Tool

302175

- Designed for bezel nuts
- Removes and replaces aerials and antennas
- 185mm overall length



Thread Chaser Spark Plug 14mm x 18mm

302168

- Tapered, double-ended design to dress or repair 14 and 18mm spark plug threads
- Simply run the tool through the damaged thread to remove carbon and dirt whilst at the same time, straightening and de-burring it
- Use with a deep socket, open-end spanner or box wrench



Spark Plug Thread Insert Kits 14mm, 18mm

- Repairs damaged threads on aluminium cylinder heads
- Replacement inserts available (see below)

Installation: Carefully tap out the damaged thread using the tap supplied. The repaired thread will enable the screw insertion of one of the above steel inserts depending on length



302300

Part No.	Diameter	Contents
302176	14mm	14mm Tap. Inserts (one of each) 10mm, 11mm, 13mm, 19mm
302300	18mm	18mm Tap. Inserts (one of each) 11mm, 13mm, 16mm, 21mm

302301

Replacements Insert

Part No.	Description	Length
302177	14mm Replacement inserts for 302176	10mm, 11mm, 13mm, 19mm
302301	18mm Replacement inserts for 302300	11mm, 13mm, 16mm, 21mm



High Tension System Tester

302158

- Four piece kit, red transparent material
- Visual check for plug firing

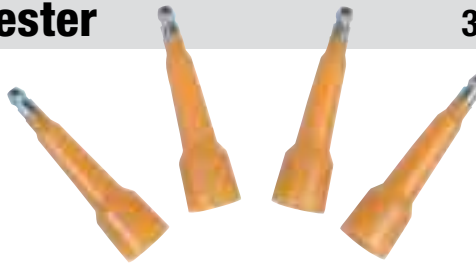

Spark Plug Lead Tester

302166

- Inductive pick-up enables faulty lead location without piercing the wires and eliminates electric shocks
- Flashing light indicates the lead is functioning



Heavy Duty Spark Plug Firing Tester

302167

- Checks spark to measure ignition voltage without plug removal
- Suits both conventional and electronic systems
- Simply adjust the calibration screw to the proper gap size and connect the plug lead to the tester
- Ground the tester with the clamp on the engine and start engine to check the spark



Ignition Spark Tester Box Type

302165

- Checks spark to measure ignition voltage without removal of spark plugs
- Suits electronic and standard ignition systems

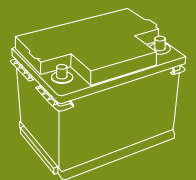
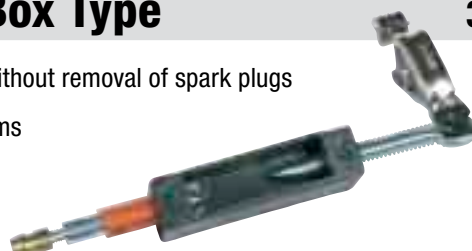

Electrical
Service

Spark Plug Starter

302157

- Universal size, fits all spark plugs
- Flexible shaft permits access from many angles
- Soft tip is stepped to grip both plug terminal and porcelain securely



Flexible Shaft Spark Plug Starter & Remover

302159

- Rubber tip holds both terminal and porcelain securely
- Flexible shaft for hard to reach plugs
- Eliminates hot engine burns when removing plugs
- 225mm overall length



Flexible Spark Plug Installer

302002

- Holds, aligns and commences thread tightening for plugs located in difficult access positions
- Length 316mm

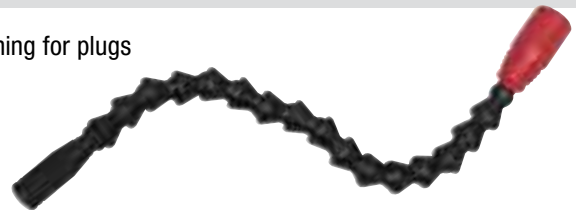

Spark Plug Gap Gauge

302163

- Accurately sets spark plug gaps
- Place the spark plug onto the tapered gauge and then turn until the correct gap setting is obtained



Flexible Spark Plug T-Bars

- Ideal for spark plug removal and replacement in recessed cylinder heads
- PVC coated handle for comfortable grip

302169

302170



Part No.	Size	Description
302169	21mm	225mm T-Bar with flexible head
302170	16mm	225mm T-Bar with flexible head

Connector Release Tool

302174

- Disconnects modern electrical connections
- Two separate tools provide different working angles

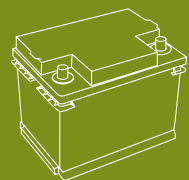
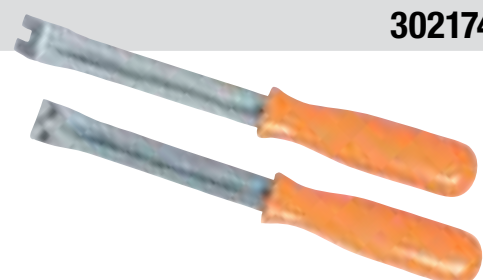

Spark Plug Sockets

- Two piece set
- Chrome vanadium steel
- Permanent magnet insert holds plugs securely
- Universal joint allows easy replacement of recessed spark plugs

302171



302172



Part No.	Sq Drive	Size
302171	3/8"	16mm (5/8") and 21mm (13/16")
302172	1/2"	16mm (5/8") and 21mm (13/16")

Offset Distributor Clamp Wrench

302173

- Eccentric shape enables access to hard to reach areas around the distributor
- Double ended wrench with popular sizes 1/2" & 9/16"
- Tool may be used in conjunction with 3/8" sq dr ratchet or accessory bar



Battery Tester (Hydrometer)

303182

- Test battery SG fast and accurately; hot or cold. Colour coded scale indicates: recharge (red), fair (grey) or good (blue)
- Suits 6, 12 or 24 volt systems and unit detects overcharge
- Draw up fluid to level line and tap gently to remove bubbles
- Top pointer must be vertical. Large pointer shows SG
- Batteries should be recharged where SG levels drop below 1210
- Batteries should be replaced where SG levels vary more than 30 between cells

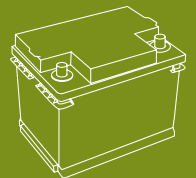

Electrical
Service

Battery Hydrometer

303184

- Economical hydrometer which provides accurate SG readings for any professional or semi-professional operator
- Readings below 1210 indicate a need for recharge. Variations of more than 30 between cells indicate battery replacement is required



Battery Hydrometer & Thermometer

303183

- Good quality hydrometer which takes ambient temperature into account when assessing SG readings
- Graduated scale on the meter advises the operator to add or subtract certain values above or beyond 26.6°C (80°F)
- 280mm overall length with 50mm thermometer



Battery Terminal Puller

303175

- Twin puller removes battery terminals
- Features spring loaded jaws and vinyl ends for easy and comfortable grip
- The puller jaws are easily positioned under the terminal and the forcing screw is tightened

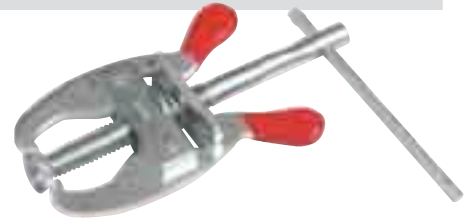

Battery Terminal/Bearing Puller

303176

- Twin puller removes battery terminals, small gears, pulleys and bearings on electric motors
- Durable sharp jaws
- The puller jaws are easily positioned under the terminal, pulley, bearing etc and the forcing screw is tightened



Battery Post & Terminal Cleaner

303177

- Cleans corrosion and dirt from battery posts and terminals
- Unit comes complete with two stainless steel brushes, internal and external



Battery Post & Terminal Cleaner

303178

- Four way tool for battery servicing
- Cleans corrosion and dirt from battery posts and terminals
- Contains a post reamer for positive and negative posts

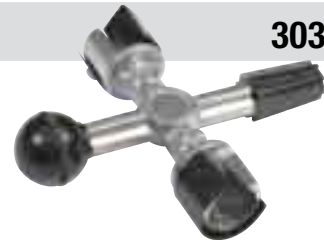

Battery Terminal Cleaning Brush

303004

- Cleans battery terminals, clamps and bolts
- Double sided
- Heavy duty brass bristles



Battery Terminal Spreader & Reamer

303179

- Drop forged
- The sharp teeth on the pliers clean and spread terminals
- Comfortable grip
- Bowed handles, vinyl dipped

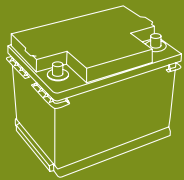

Electrical
Service

Professional Battery Carrier

303180

- Scissor lock type jaws with serrated teeth ensure a positive grip on the side of the battery
- Caters for batteries up to 175mm (7") wide
- Sturdy leather handle for lifting and carrying batteries



Battery Carrier Heavy Duty

303181

- Enables single-handed, sure and safe battery removal and replacement
- Solidly constructed zinc plated arms
- Carrying arms extend to 195mm width via a ratchet tooth adjustment
- 80 x 35mm grips with acid resistant, serrated rubber pads ensure a firm grip on the battery



Battery Side Terminal Ratchet Wrench

303001

- Suits 5/16" nuts
- Reversible ratchet removes battery terminal bolts easily
- PVC coated handle



Battery Terminal Spreader & Reamer

303002

- Spreads terminals for easy fit to posts
- Reamer cleans inner face of terminal for clean connection



Electrical Surge Protector (12V)

303003

- Provides protection against voltage spikes and surges
- Designed for use on 12 volt systems
- Clamps to battery terminals prior to welding

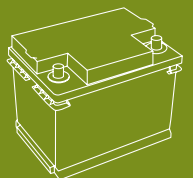

Electrical
Service